

5

CHANNELS

- OLED display
- 8 bit / 16 bit
- 3 kinds of DMX interfaces
- Dimming curve: 0.1-9.9
- Short circuit / Over current / Over-heat protection



Product Introduction

1. Designed with 5 channels output, and Max. 6A current per channel, up to 720W output power.
2. Easy operation with OLED screen and the touch buttons.
3. 5 kinds of mode optional: single color, CT, RGB, RGBW, RGBWY.
4. Support 3 kinds of DMX ports with signal isolation function: 3-pin XLR, RJ45 and green terminal (with signal amplifier function).
5. With RDM remote management protocol, the operations can be completed via the RDM master console, such as parameters browsing & setting, DMX address setting, equipment recognition, etc.
6. With firmware upgrade function.
7. With short circuit, over current and over-heat protection, as well as warning function when fault.
8. With power-on state management and fast self-testing function.
9. 16bit (65536 levels) / 8bit (256 levels) grey level optional.
10. Optional for standard, linear, LOG or custom 0.1-9.9 dimming curve.

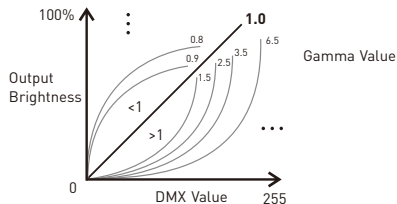

Technical Specs

Model:	LT-995-OLED
Input Signal:	DMX512/RDM
Input Voltage:	12-24Vdc
Current Load:	6A × 5CH Max. 30A
Output Power:	(0-72W...144W) × 5CH Max. 720W
DMX Interface:	3-pin XLR, RJ45, green terminal
Control Mode:	Dimming/CT/RGB/RGBW/RGBWY
Dimming Curve:	0.1-9.9
Grey Level:	8bit (256 levels) / 16bit (65536 levels)
Photoelectric Isolation:	Yes
Protection:	Short circuit / Over current / Over-heat protection, recover automatically
Working Temperature:	-30°C-65°C
Dimensions:	L169×W80×H39mm
Package Size:	L182×W91×H41mm
Weight (G.W.):	550g

Unit: mm

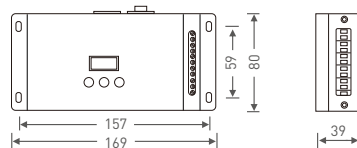

Main Component Description

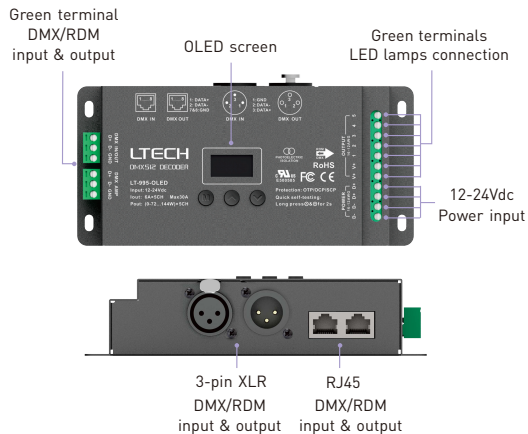

OLED Screen Interface



Press "M" key, switch entries.
 Long press "M" key, back to main page.
 Press "^" or "v" key, parameter adjustment.
 Exit: back to previous page.

1. DMX Address Setting

DMX: 001 Hz: High
 Mode: RGB 8bit
 Curve: Standard
 Dim: Smo TOOL&v

Press "^" or "v" key to set DMX address.
 Range: 001-512

Main page

2. PWM Frequency

DMX: 001 Hz: High
 Mode: RGB 8bit
 Curve: Standard
 Dim: Smo TOOL&v

Press "^" or "v" key to choose.
 Optional : Std (standard) High Mid (middle) Low

Smooth and delicate, human eye is comfortable. * It is recommended to use standard.

No flicker in video camera.

3. Mode

DMX: 001 Hz: High
 Mode: RGB 8bit
 Curve: Standard
 Dim: Smo TOOL&v

Press "^" or "v" key to choose.
 Optional : Dim / CT
 RGB / RGBW / RGBWY

4. Grey Level

DMX: 001 Hz: High
 Mode: RGB 8bit
 Curve: Standard
 Dim: Smo TOOL&v

Press "^" or "v" key to choose.
 Optional : 8bit
 16bit (choose it if the master controller support this function)

5. Dimming Curve

DMX: 001 Hz: High
 Mode: RGB 8bit
 Curve: Standard
 Dim: Smo TOOL&v

Press "^" or "v" key to choose.
 Optional : Standard
 Linear
 LOG
 0.1-9.9

It is recommended to use standard, 0.1-9.9 is for special requirements.

6. Enhance Dimming

DMX: 001 Hz: High
 Mode: RGB 8bit
 Curve: Standard
 Dim: Smo TOOL&v

Press "^" or "v" key to choose.
 Optional : Std (standard) Smo (smooth)
 * It is recommended to use standard.
 Smo: This option with smooth processing, realize the dimming flicker-free and dynamic effects more downy.

7. Tool

DMX: 001 Hz: High
 Mode: RGBW 8bit
 Curve: Standard
 Dim: Smo TOOL&v

Press "^" or "v" key to enter submenu.

Screen: ON+Addr
 Contrast: 40%
 Beep: ON TEST&V EXIT&V

Press "^" or "v" key to enter submenu of test.

001

Brightness setting (range: 0-255)
 Press "v" to exit

CH1: 255 CH2: 255
 CH3: 255 CH4: 255
 CH5: 255 ALL: 255
 EXIT &V

Screen: ON+Addr
 Screensaver open and display address if undo for 2 minutes.

Screen: ON+black
 Screensaver open and black if undo for 2 minutes.

DMX: 001 Hz: High
 Mode: RGBW 8bit
 Curve: Standard
 Dim: Smo TOOL&v

Screen: OFF
 Screensaver not enable.

* Fast self-testing function: press "^" or "v" keys simultaneously for 2-3 seconds under any page, decoder will enter self-testing function.

Wiring Diagram

1 Connecting LED lights:

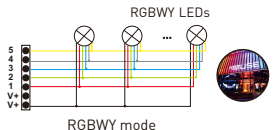
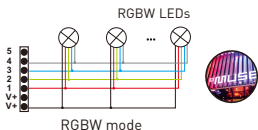
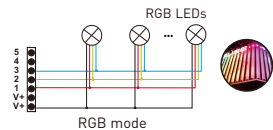
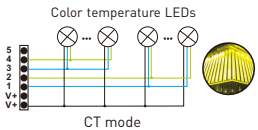
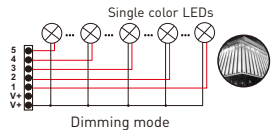
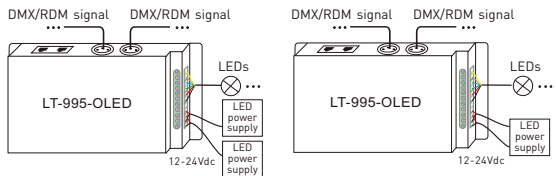

2. DMX console connection:

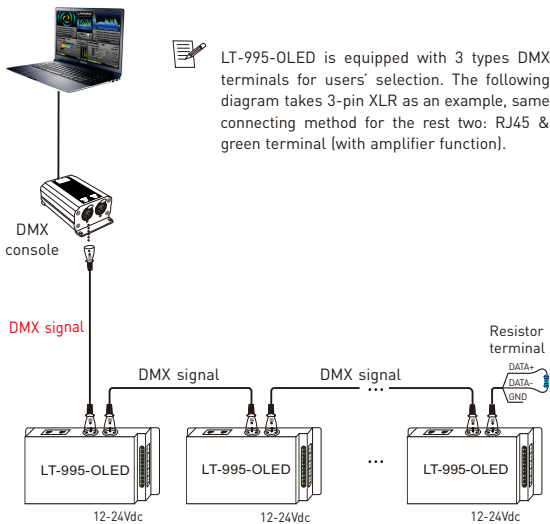

LT-995-OLED is equipped with 3 types DMX terminals for users' selection. The following diagram takes 3-pin XLR as an example, same connecting method for the rest two: RJ45 & green terminal (with amplifier function).

* An amplifier is needed if more than 32 decoders are connected or use overlong signal line, signal amplification should not be more than 5 times continuously.

* If the recoil effect occurs because of longer signal line or bad line quality, please try to connect 0.25W 90-120Ω terminal resistor at the end of each line.

3. The connection diagram of 3 kinds of DMX/RDM terminals:

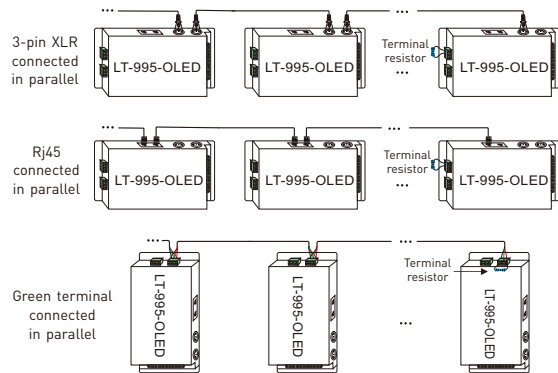

These 3 terminals can be connected in a mixed way.

4. The connection diagram of AMP signal amplifier terminal:

* Connecting with green terminal or an extra amplifier will be needed when more than 32 decoders are connected or use overlong signal wire(as shown below). Signal amplifier should not be more than 5 times continuously.

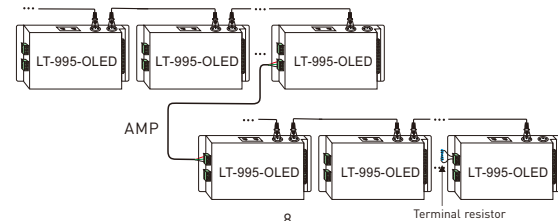

Address setting table

Mode	DIM	CT	RGB	RGBW	RGBWY	
Address Quantity	1	2	3	4	5	
Resolution	8bit	8bit	8bit	8bit	8bit	
Channel	1	001	001	001	001	001
	2	001	002	002	002	002
	3	001	001	003	003	003
	4	001	002	003	004	004
	5	001	002	003	004	005

Mode	DIM	CT	RGB	RGBW	RGBWY	
Address Quantity	2	4	6	8	10	
Resolution	16bit	16bit	16bit	16bit	16bit	
Channel	1	001 002	001 002	001 002	001 002	001 002
	2	001 002	003 004	003 004	003 004	003 004
	3	001 002	001 002	005 006	005 006	005 006
	4	001 002	003 004	005 006	007 008	007 008
	5	001 002	003 004	005 006	007 008	009 010

Work with RDM Editor

LT-995-OLED can work with LTECH RDM editor (Model: WiFi-RDM01) to realize changing the parameters by long-range setting, wiring diagram as below:

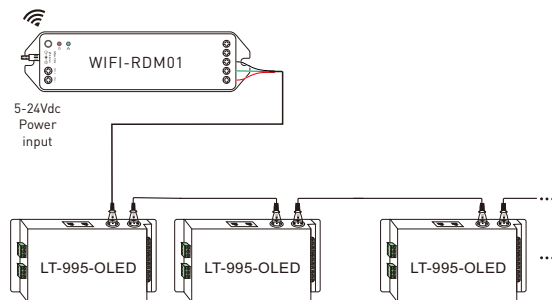

RDM Editor APP Interface Instruction

Download the APP, setting the LT-995-OLED parameters (frequency, bit, curve, modes, dimming range, screensaver, etc.) after well connecting the RDM editor, more details, please check the manual of WiFi-RDM01.

Well installation of products first, then working with WiFi-RDM01 to realize setting parameters and firmware upgrade by APP.

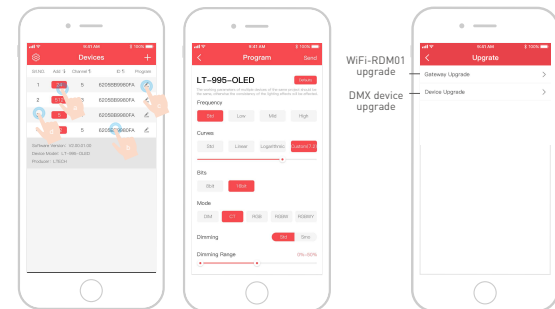

- click "Add", edited the address in corresponding box.
- Click "ID", get more product details.
- Click " ", enter edited interface
- Click "No.", issue the recognizing command.

Supporting WiFi-RDM01 upgrade and DMX driver upgrade.

※ No further notice if any changes in the manual.
Product function depends on the goods.
Please feel free to contact your supplier if any question.